

TOP VIEW

2'-11 1/4"
(895 mm)

POST WITH
METAL DOME TOP

0'-0"

FINISHED GRADE

FRONT VIEW

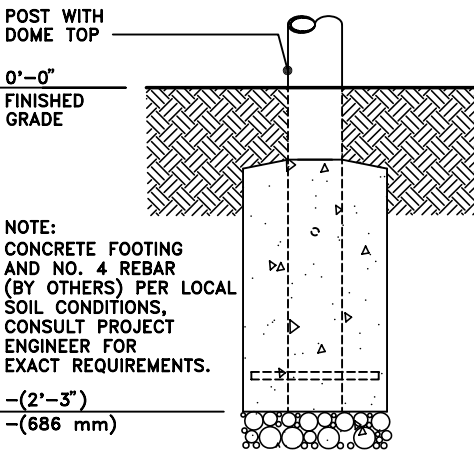
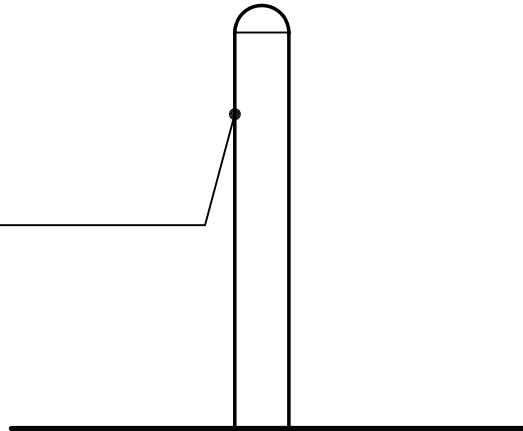

2190-E (EMBEDMENT MOUNTING)

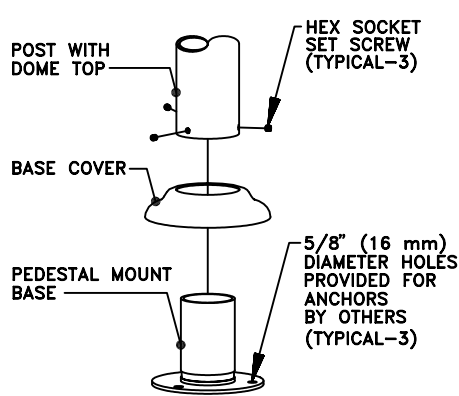

2190-P (PEDESTAL MOUNTING)

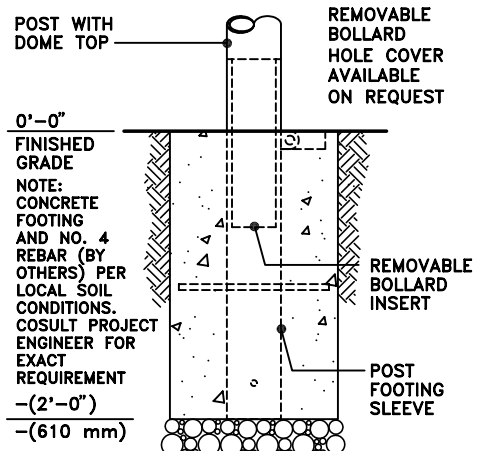

2190-R (REMOVABLE MOUNTING)

This drawing reveals the copyrighted intellectual property of Columbia Cascade Company. Not for use by others without our express, written authorization.
Authorization for use is hereby granted to architects, landscape architects and similar design professionals solely for the purpose of specifying TimberForm products.

COLUMBIA CASCADE COMPANY
Makers of TimberForm®, PipeLine®,
RePlay®, TimberForm®-2, InterPlay®,
CycLoops® and CycLocker® Products.

Title:
**TIMBERFORM
MODEL NO. 2190
METAL BOLLARD**

1300 S.W. Sixth Avenue, Suite 310 Telephone 503/223-1157
Portland, Oregon 97201-3464 Facsimile 503/223-4530
U.S.A.

WWW.TIMBERFORM.COM

Drawing No.
W-2190

Sheet
1 of 1

Scale
3/4" = 1'-0"

Drawn by: AT 07-04-10
Ck'd by: