

TOP VIEW

2'-11 1/4"
(895 mm)

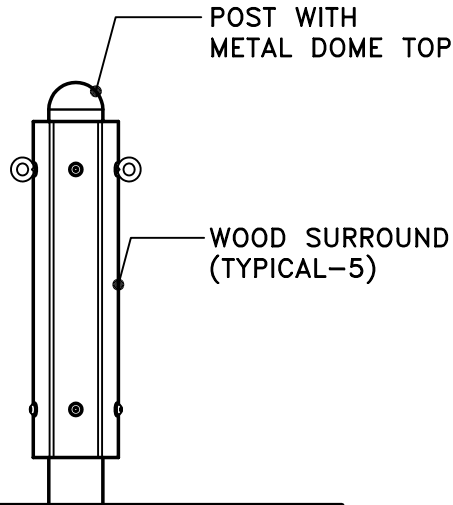

0'-0"

FINISHED GRADE

FRONT VIEW

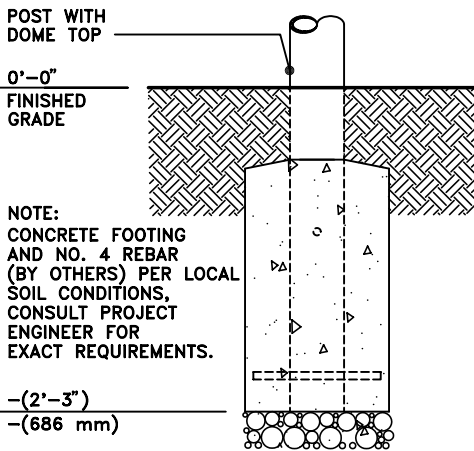

2197-E (EMBEDMENT MOUNTING)

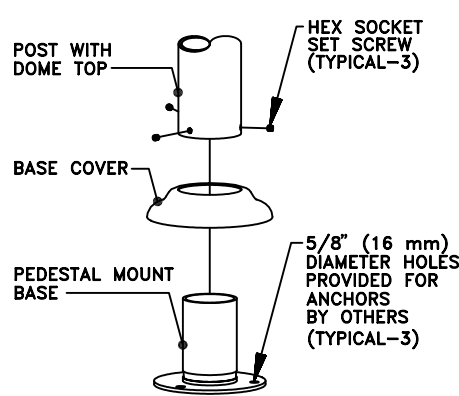

2197-P (PEDESTAL MOUNTING)

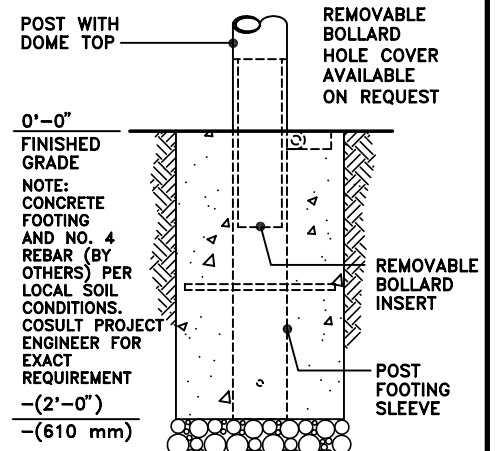

2197-R (REMOVABLE MOUNTING)

This drawing reveals the copyrighted intellectual property of Columbia Cascade Company. Not for use by others without our express, written authorization.

Authorization for use is hereby granted to architects, landscape architects and similar design professionals solely for the purpose of specifying TimberForm products.

COLUMBIA CASCADE COMPANY
Makers of TimberForm®, PipeLine®, RePlay®, TimberForm®-2, InterPlay®, CycLoops® and CycLocker® Products.

Title:
**TIMBERFORM
MODEL NO. 2197
METAL BOLLARD WITH SURROUND**

1300 S.W. Sixth Avenue, Suite 310 Telephone 503/223-1157
Portland, Oregon 97201-3464 Facsimile 503/223-4530
U.S.A.

WWW.TIMBERFORM.COM

Drawing No.
W-2197

Sheet
1 of 1

Scale
3/4" = 1'-0"

Drawn by: AT 07-04-10

Ck'd by: