

TOP VIEW

3'-6"
(1067 mm)

12 X 12 (NOM.)
F.O.H.C. DOUGLAS
FIR BOLLARD

0'-0"

FINISHED GRADE

FRONT VIEW

END VIEW

MODEL NO. 2562-2.5 (2'-6" ABOVE FINISHED GRADE)
 MODEL NO. 2562-3 (3'-0" ABOVE FINISHED GRADE)
 MODEL NO. 2562-3.5 (SHOWN)

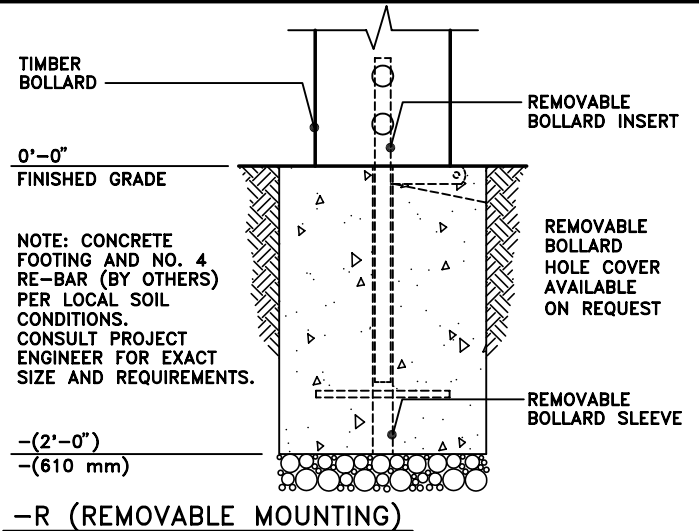
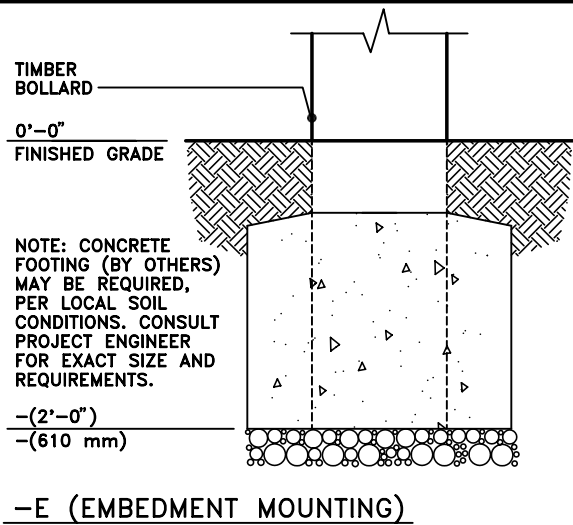

This drawing reveals the copyrighted intellectual property of Columbia Cascade Company. Not for use by others without our express, written authorization.

Authorization for use is hereby granted to architects, landscape architects and similar design professionals solely for the purpose of specifying TimberForm products.



COLUMBIA CASCADE COMPANY

Makers of TimberForm®, PipeLine®, RePlay®, TimberForm®-2, InterPlay®, CycLoops® and CycLocker® Products.

1300 S.W. Sixth Avenue, Suite 310 Telephone 503/223-1157
 Portland, Oregon 97201-3464 Facsimile 503/223-4530
 U.S.A.

WWW.TIMBERFORM.COM

Title:

TIMBERFORM
 MODEL NO. 2562
 12 x 12 TIMBER BOLLARD



Scale
 3/4" = 1'-0"

Drawn by: AT 07-04-10
 Ck'd by:

Drawing No.
 W-2562

Sheet
 1 of 1