

TOP VIEW
SCALE: 1"=1'-0"

2'-10"
(864 mm)

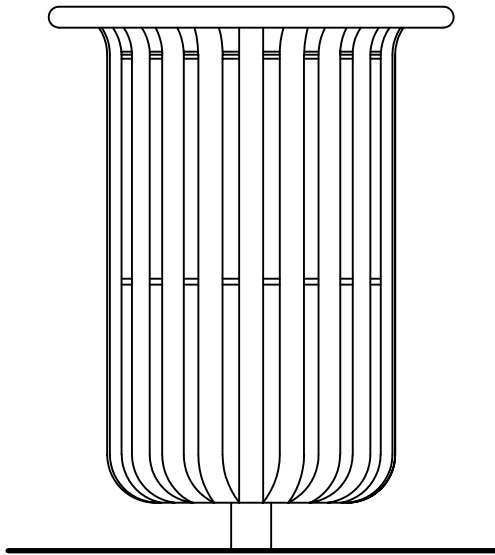

0'-0"
FINISHED GRADE

FRONT VIEW
SCALE: 1"=1'-0"

INCLUDES 23-GALLON RECYCLED PLASTIC LINER.
SEE DETAILS AT RIGHT FOR INDIVIDUAL MODELS.

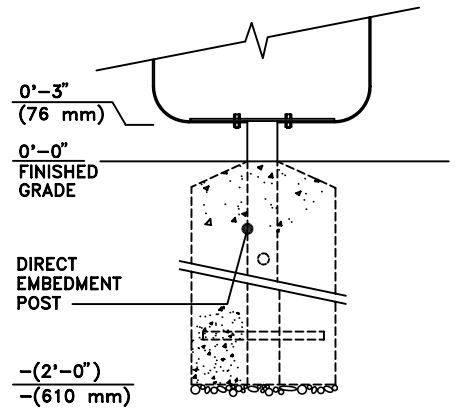

NOTE:
CONCRETE FOOTING AND NO. 4 REBAR (BY OTHERS) PER LOCAL SOIL CONDITIONS. CONSULT PROJECT ENGINEER FOR EXACT REQUIREMENTS.

2811-FT-E (EMBEDMENT)
SCALE: 3/4"=1'-0"

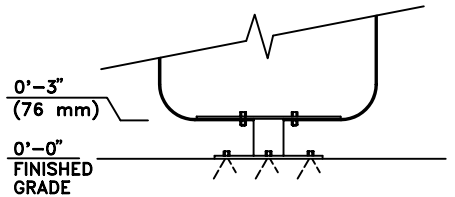
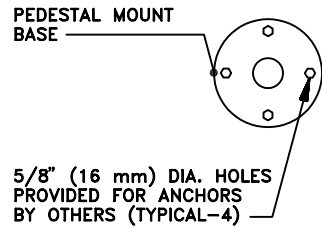

2811-FT-P (PEDESTAL MOUNT)
SCALE: 3/4"=1'-0"

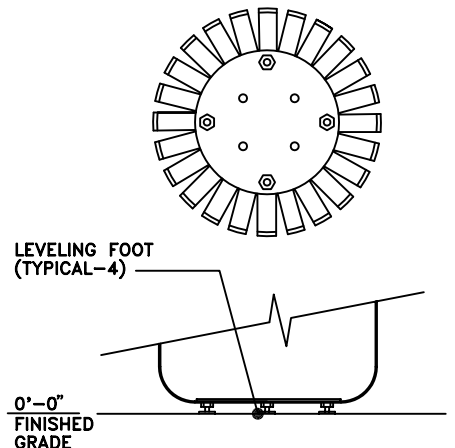

2811-FT-L (LEVELING MOUNT)
SCALE: 3/4"=1'-0"

This drawing reveals the copyrighted intellectual property of Columbia Cascade Company. Not for use by others without our express, written authorization.

Authorization for use is hereby granted to architects, landscape architects and similar design professionals solely for the purpose of specifying TimberForm products.



COLUMBIA CASCADE COMPANY

Makers of TimberForm®, PipeLine®, RePlay®, TimberForm®-2, InterPlay®, CycLoops® and CycLocker® Products.

1300 S.W. Sixth Avenue, Suite 310 Telephone 503/223-1157
Portland, Oregon 97201-3464 Facsimile 503/223-4530
U.S.A.

WWW.TIMBERFORM.COM

Title:
TIMBERFORM RENAISSANCE
MODEL NO. 2811-FT
LITTER CONTAINER
WITH FLAT TOP



Scale NOTED
Drawn by: AT 07-04-10
Ck'd by:

Drawing No.
W-2811-FT

Sheet
1 of 1