

TOP VIEW

2'-6"
(762 mm)

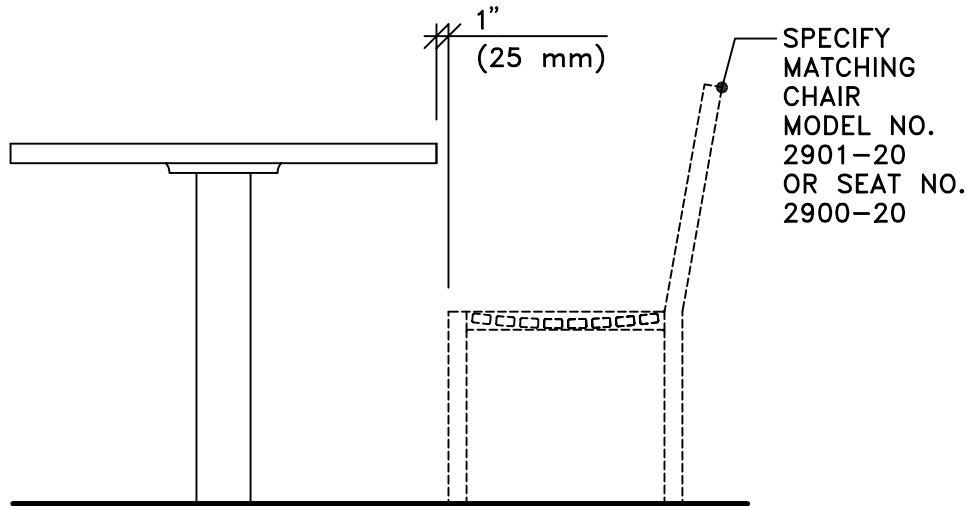

0'-0"
FINISHED GRADE

FRONT VIEW

SPECIFY NO. 2903 FOR OPTIONAL GAMEBOARD OR NO. 2904 FOR UMBRELLA HOLE.

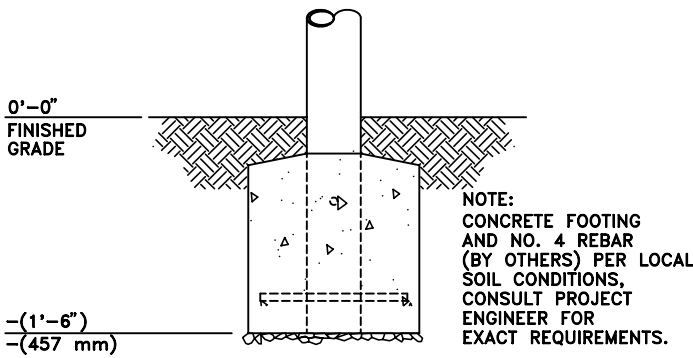

2902-0036-E (DIRECT EMBEDMENT)

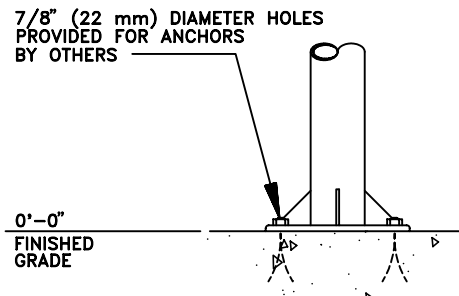

2902-0036-P (PEDESTAL MOUNT)

This drawing reveals the copyrighted intellectual property of Columbia Cascade Company. Not for use by others without our express, written authorization.

Authorization for use is hereby granted to architects, landscape architects and similar design professionals solely for the purpose of specifying TimberForm products.



COLUMBIA CASCADE COMPANY

Makers of TimberForm®, PipeLine®, RePlay®, TimberForm®-2, InterPlay®, CycLoops® and CycLocker® Products.

1300 S.W. Sixth Avenue, Suite 310 Telephone 503/223-1157
Portland, Oregon 97201-3464 Facsimile 503/223-4530
U.S.A.

WWW.TIMBERFORM.COM

Title:
TIMBERFORM MANOR TABLES
MODEL NO. 2902-0036
ROUND TABLE WITH CENTER SUPPORT



Scale 3/4" = 1'-0"
Drawn by: AT 07-04-10
Ck'd by:

Drawing No.
W-2902-0036

Sheet
1 of 1